

Lightweight Pneumatic Plane Grip, Single actuator, QC fitting

Mec94 – aluminium

A versatile lightweight pneumatic grip especially suitable for holding a variety of materials where the tensile force may be low but the material is sensitive to damage or slippage when clamped. The adjustable screw-driven rod allows symmetrical and asymmetrical specimens to be positioned whilst the single-actuator applies the clamping force on the jaws. Adjustment of pneumatic pressure ensures a constant and reproducible clamping force is achieved to avoid 'jaw break' or slippage of specimens. Its low-profile aluminium design makes it ideal for tensile testing with loadcells of capacity as low as 10 N.

- Clamping force: 200 N / 7 bar
- Opening: 0-20 mm (depending on jaws)
- Pneumatic connection: M5 suitable for fitting with tubes supplied with additional foot pedal (eg. Mec205-1)
- Weight: 214 gram each grip (without jaws)

Jaws for Mec94: Scope of delivery 0.5 set = 2 jaws (left & right).
Order any combination of 2 half-sets of jaws to fit into a pair of Mec94 grips (upper & lower)

Item No.	Surface	Clamping Surface H x W	Opening (A)	Weight per 0.5 set
Mec94-B	Blank jaws	25 x 25 mm	0 - 20 mm	53 gram
Mec94-BG	Rubber jaws	25 x 25 mm	0 - 18 mm	56 gram
Mec94-BP	Pyramid jaws	25 x 25 mm	0 - 20 mm	49 gram
Mec94-BD	Diamond jaws	25 x 25 mm	0 - 20 mm	54 gram
Mec94-B50	Blank jaws	25 x 50 mm	0 - 20 mm	111 gram
Mec94-BG50	Rubber jaws	25 x 50 mm	0 - 18 mm	114 gram
Mec94-BP50	Pyramid jaws	25 x 50 mm	0 - 20 mm	104 gram
Mec94-BW50	Wave jaws	25 x 50 mm	0 - 16 mm	128 gram
Mec94-BD50	Diamond jaws	25 x 50 mm	0 - 20 mm	112 gram

Jaws with other dimensions and surface coatings on request

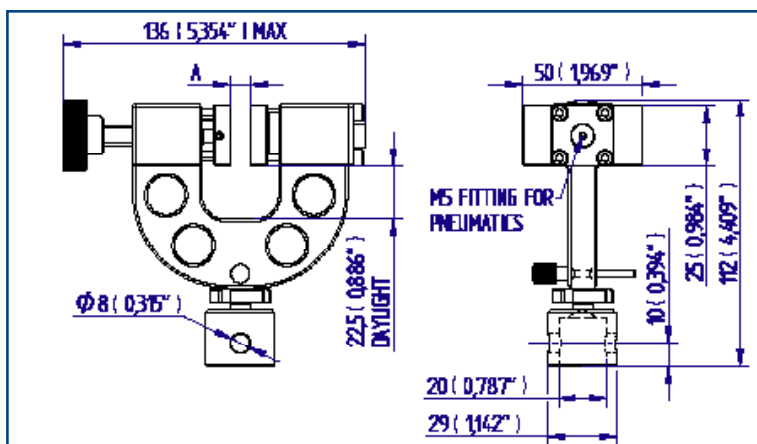

*Q = Quick-interchange via 8 mm Ø pin

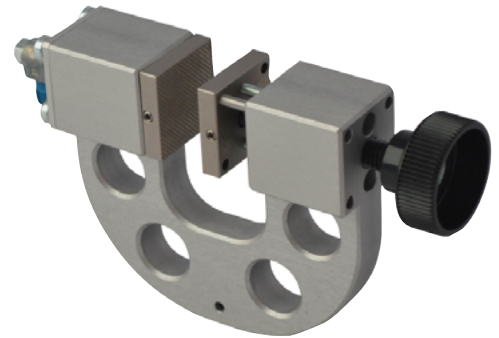

Mec94 shown with
Mec94-B jaws fitted

Ordering information Item No.: Mec94

Scope of delivery: 1 pair of grips supplied with adaptors to allow connection to QC-20 fixing posts.

Foot pedals (see overleaf) and jaws (see table below) must be ordered separately.

Item No:	Mec94
Clamping force:	200N / 7 bar
Opening:	0-20mm (depending on jaws)
Pneumatic connection:	M5 – fits to tubes supplied with foot pedals (eg Mec 205-1)
Weight:	214 g per grip (without jaws)

Blank jaws

- Steel blanks
- Applicable for own further treatments

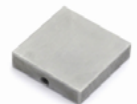

Rubber jaws

- 1 mm rubber coating

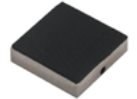

Pyramid jaws

- Pyramids 1x45°
- Hardened steel 58 HRC

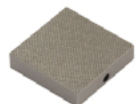

Wave jaws

- Wave 5 mm
- Hardened steel 58 HRC



Diamond jaws

- Coated with synthetic diamonds

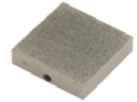

Examples for Mec94 with jaws fitted

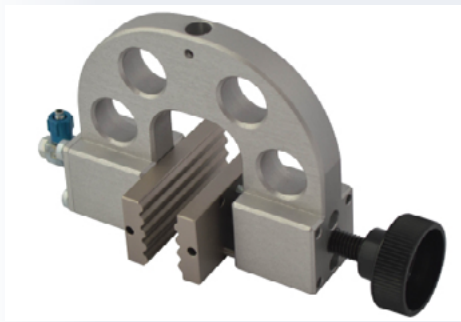

Mec94 with Mec94-BW50 jaws

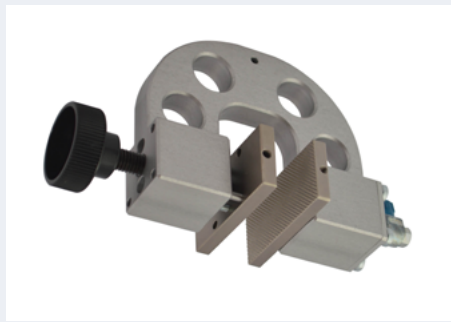

Mec94- with Mec94-BP50 jaws



Mec94 with Mec94-B100x25 special blank jaws

Accessories

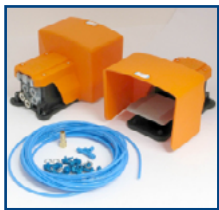

Mec205-1 Foot pedals

Non-locking: The jaws of the grip open by pressing the foot pedal and close after removing the foot from the pedal. Scope of delivery: 1 pair of foot switches including tubes and fittings.



Mec205-2 Foot pedals

With locking function: The jaws of the grip open by pressing the foot pedal and remain opened after removing the foot from the pedal. The jaws close by pressing the pedal one more time. Scope of delivery: 1 pair of foot switches including tubes and fittings.

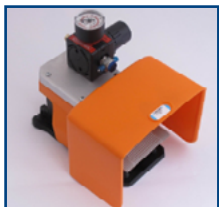

Mec205-+PR Pressure regulator

Optional for Mec205-1 or Mec205-2 To adjust air pressure: 1-10 bar or 1-16 bar



Mec205-3 Hand switches

With locking function: The jaws of the grip close by pulling the handle and remain closed. The jaws open by pushing the handle back. Scope of delivery: 1 unit of hand switches including tubes and fittings.



Mec216 Compressor for laboratories, oil-lubricated

Max pressure 16 bar, 230 V, frequency 50 Hz, noise level: 38 dB (A)/1 m. Displacement 5 l/min, tank size 3.1 l (0.82 gallon) Dimensions: 382x300x334 mm (D x W x H); weight 24 kg Different voltages available on request.

For more information on QC fittings, refer to datasheet 431-354 Adapters for QC range of grips.



FS 58553

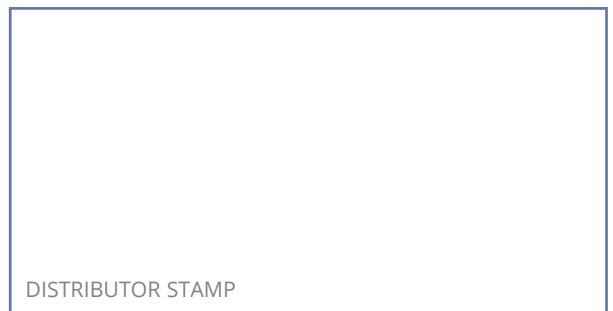

Mecmesin reserves the right to alter equipment specifications without prior notice. E&OE

Head Office
Mecmesin Limited

w: www.mecmesin.com
e: sales@mecmesin.com

France
Mecmesin France

w: www.mecmesin.com/fr
e: contact@mecmesin.fr

Germany
Mecmesin GmbH

w: www.mecmesin.com/de
e: info@mecmesin.de

North America
Mecmesin Corporation

w: www.mecmesin.com
e: info@mecmesincorp.com

Asia
Mecmesin Asia Co., Ltd

w: www.mecmesin.com/th
e: sales@mecmesinasia.com

China
Mecmesin (Shanghai) Pte Ltd

w: www.mecmesin.com/zh
e: sales@mecmesin.cn