

2.5 kN Bend Jig, QC fitting

Mec238 - aluminium

A 2.5 kN Bend Jig in aluminium having a bending span up to 150 mm and a beam width of 30 mm.

A comprehensive selection of Mec238 anvil types and sizes are available to allow you to configure for 3-point or 4-point flexure bend testing.

'Upper' anvils and the 'lower' bending beam are supplied fitted with a bore hole to allow connection to a QC-20 fixing post.

Below you will see an example configuration showing:

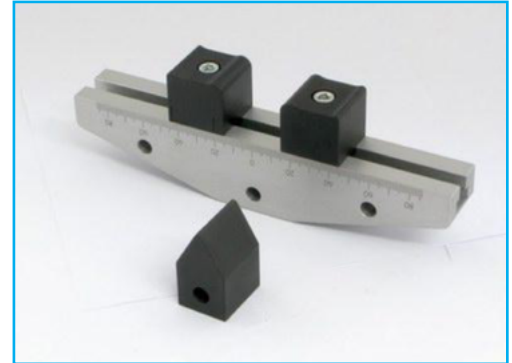

- 'Lower' anvils Type A = 'dual' anvil having milled edge radii of 2mm and 3mm
- 'Upper' anvil Type O = single anvil having milled edge radius of 2mm
- 'Lower' bending beam (B) of 150mm length with QC-20 bore hole

This generates a combined part number of : Mec238-AR3R2-OR2-B150-QC20

Dimensions mm

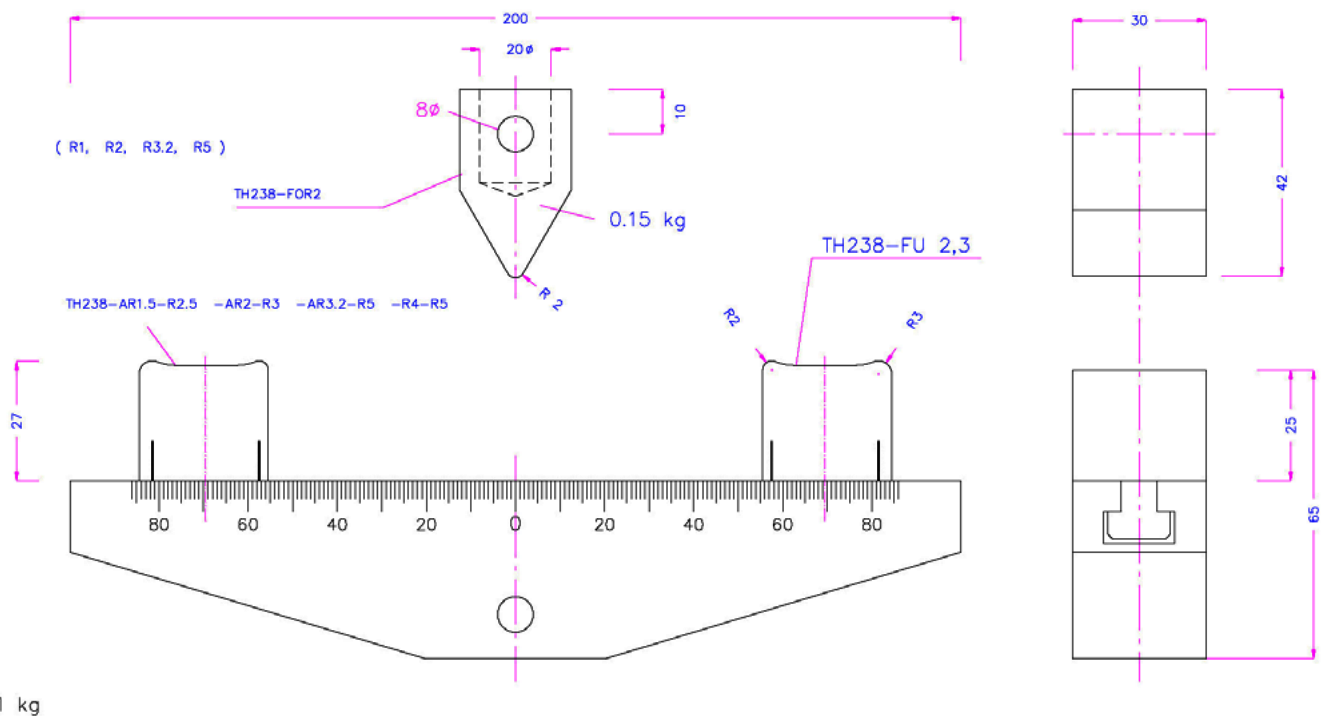

The illustrations overleaf are selected examples of the component parts and assemblies to build precisely the bending jig you require. You choose:

- Bending beam length (lower)
- Bending beam length (upper) ... only applicable if you wish to perform 4-point flexure bend testing
- 'Lower' and 'Upper' anvil type (roller or milled-edge) and their dimensions
- Special requirements (eg. Wide anvils for large specimens, tall anvils for folding tests, movement in anvils for increased accuracy)

Please refer to the outline at the back of this datasheet for how to identify and specify the components you require.

Bend jig configurations

3-point bending jig

Lower radii 1, 2, 3, 4, 5, 8, 10
Upper radius 0.5, 1, 2, 3, 4, 5, 8, 10



4-point bending jig with interchangeable rollers on CX anvils



4-point bending jig with interchangeable rollers

Lower AX supports
Upper CX supports
Width 30 mm



Interchangeable rollers

diameter 6 mm, width 100 mm



300 mm beam with supports for interchangeable rollers



Anvils

Anvil with dual milled radii, 2 mm and 5 mm ×2
Available radius pairs (mm):
1.5+2.5; 2+3; 2+5; 3.2+5;
4+5



Anvils with 1 milled radius edge ×2

Available radius: 0.5; 1; 1.5;
2; 2.5; 3.2; 5 mm



Special anvils with 1 milled edge ×2
CR1H130 = radius 1 mm,
height 130 mm



Anvil for interchangeable rollers ×2
Diameters 1 to 12.7 mm



Anvil for single interchangeable roller ×2



Flat simple anvil, interchangeable roller, for glass ×2

no image available

Roller, hardened, width 30 mm ×3
Diameters: 1; 2; 2.5; 3;
3.175; 4; 4.5; 5; 6; 6.35; 8;
9; 10; 12; 12.7 mm



Roller with special length + 2 O-Rings + 2 extra pins to fix or magnets to fix ×3
3x56; 3x105; 6x105; 10x105

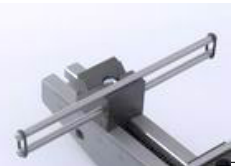

Beams



200 mm lower beam, anodised aluminium ×1

200 mm lower beam, chromed steel ×1

300 mm lower beam, chromed steel ×1

350 mm lower beam, chromed steel ×1

400 mm lower beam, chromed steel ×1

Removable insert anvils

Articulated lower carrier for removable inserts; can be fixed at an angle ×2

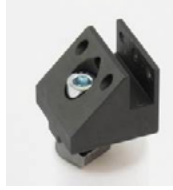

Removable insert for interchangeable roller retained by O-rings ×3



Articulated carrier for removable insert with interchangeable roller retained by O-rings ×2



Flat removable insert for glass ×2 no image available

Removable insert for interchangeable roller retained by O-rings Roller diameter 5 mm on a flat plane area, height 3 mm ×2



Wide fin removable insert for articulated carrier ×3

Radius 2 mm, width 120 mm



Zero-span removable insert ×2

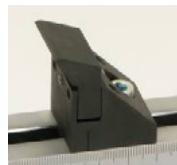

Upper anvils

Upper anvil with milled radius 1; 1.5; 2; 3; 4; 5; or 12.5 mm ×1



Upper v-notch anvil to carry different diameters ×1
OX2 holds 1–3.2 mm Ø
OX8 holds 4–12.7 mm Ø



Articulated upper carrier for removable anvil inserts; can be fixed at an angle For inserts see Mec238-W ×1



Articulated upper carrier with insert for interchangeable rollers retained by O-rings ×1



Special anvils

Anvil with removable needle-bearing insert ×2



Support with integral roller, centerline radius 5 mm ×2

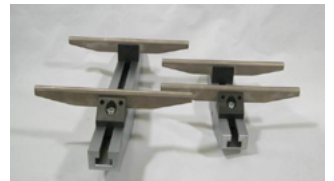

Support with diameter 10 mm tube, width 100 mm ×2



Support with non-interchangeable 60 mm wide anvil, radius 1.5 mm, for 4-point bend system ×4

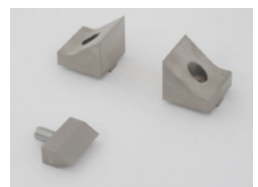

Bend jigs to your own specification

Bend jigs can be assembled to user specification to meet test requirements:

- load rating
- anvil edge type
- anvil height
- individual positioning of anvils, or by centric gearing using a leadscrew / handle.
- bending span width
- anvil movement type
- 3 or 4-point bend capability
- anvil mount type
- anvil width

Certain anvil types allow a rocking movement, adjustable angle (articulated), or flat sideways movement. For sharp angle bending (e.g. to 160°) long-fin anvils are available, along with other specialised anvils. Standard anvil types are shown below. (Roller size is denoted by diameter, milled edges are denoted by radius.)

Lower Anvils

Type A: dual-radius



A: milled edge

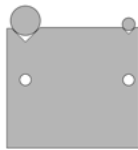

AX: v-notch roller bearings

Type C: single radius



C: milled edge

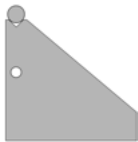

CX: v-notch roller

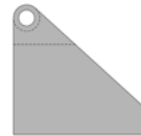

CL: captive roller



CM: roller free to traverse

Type CW, carrier style



CW: milled edge



CWX: v-notch roller

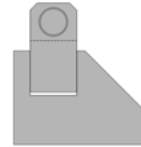

CWL: captive roller

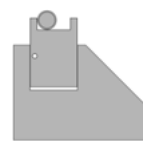

CWN: roller traverses to stop

Upper Anvils

Type O



O: milled edge



OX: v-notch roller bearing



OWX: carrier-style v-notch

How to specify your particular bend jig requirement

Let us know your requirement by:

- beam model: Mec238, Mec103, Mec22 and length (long versions available)
- aluminium or steel, and finish (where available)
- anvil mount type as above (A, C, CW, O, with extra designation of W, X, L, M or N where appropriate)
- the upper and lower anvil radii type (milled or rollers) with dimensions
- any special requirements such as anvil height or width, or movement
- if you require centric gearing (Mec103 only)
- if you require an upper support for two anvils for 4-point testing
- the QC coupling size (20 mm or 32 mm)

For full details and examples, refer to the datasheets for the three base models: Mec238, Mec103 and Mec22.

For more information on QC fittings, refer to datasheet 431-354 Adapters for QC range of grips.



FS 58553

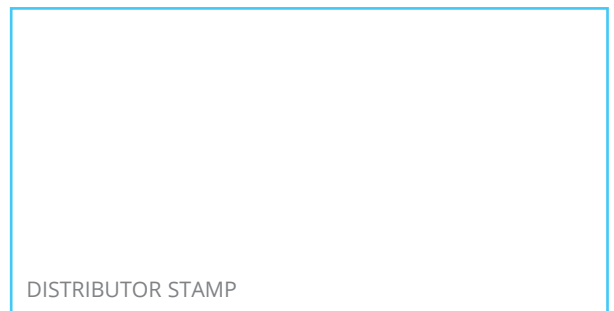

DISTRIBUTOR STAMP

Mecmesin reserves the right to alter equipment specifications without prior notice.
E&OE

Head Office
Mecmesin Limited

w: www.mecmesin.com
e: sales@mecmesin.com

France
Mecmesin France

w: www.mecmesin.com/fr
e: contact@mecmesin.fr

Germany
Mecmesin GmbH

w: www.mecmesin.com/de
e: info@mecmesin.de

North America
Mecmesin Corporation

w: www.mecmesin.com
e: info@mecmesincorp.com

Asia
Mecmesin Asia Co., Ltd

w: www.mecmesinasia.com/th
e: sales@mecmesinasia.com

China
Mecmesin (Shanghai) Pte Ltd

w: www.mecmesin.cn
e: sales@mecmesin.cn